

1. Identify all the major components of the master station

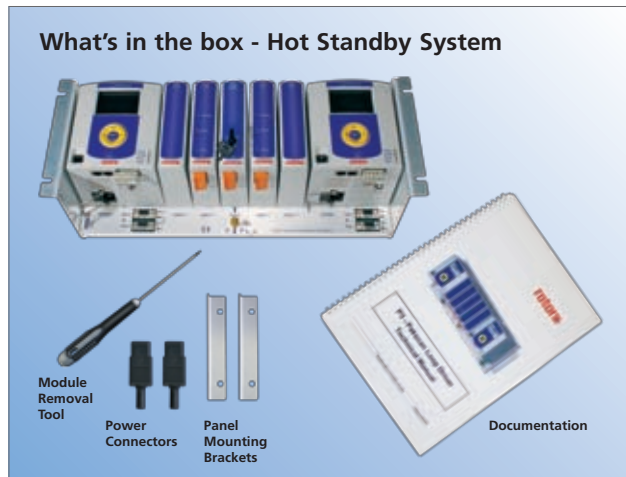

- To make the master station panel mounting, change the brackets.
- All connections and adjustments are accessible from the front.
- 24V DC units have screw connections for the power

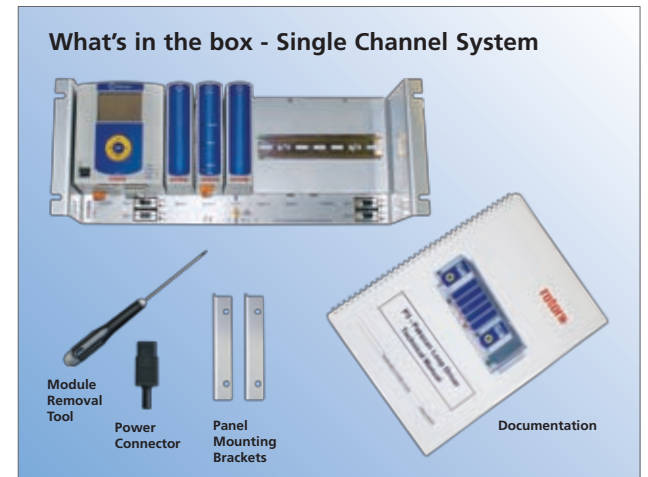
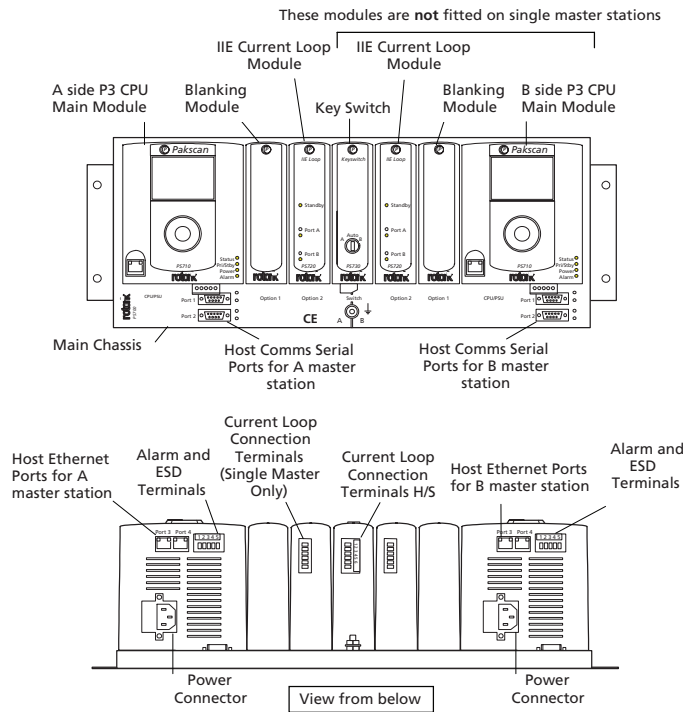

2. Connecting Up (see S720E Section 1)

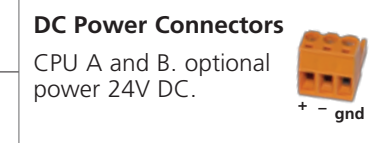
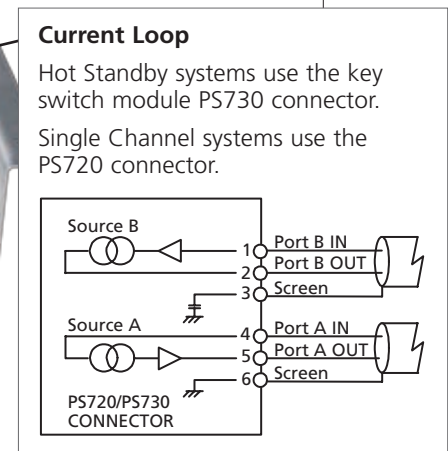
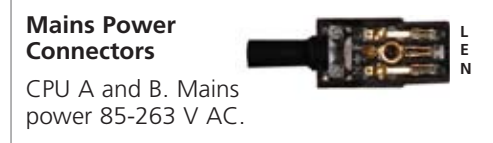
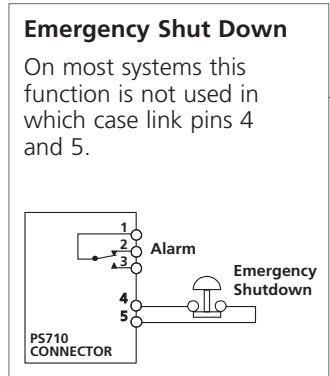
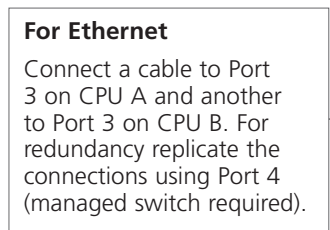
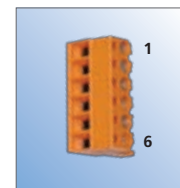
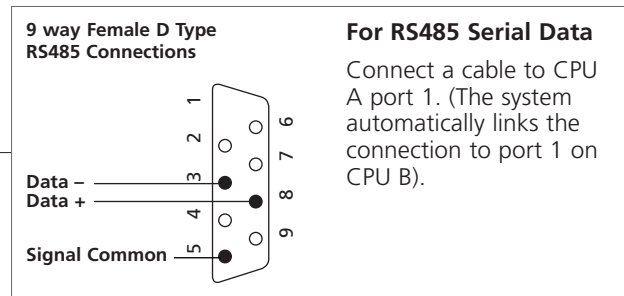
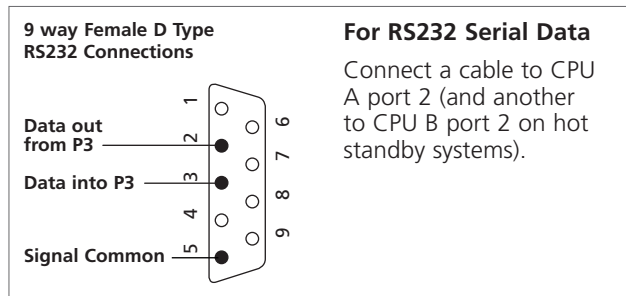

3. Current Loop (see S720E Section 2)

Loop Continuity
With all the field units connected and powered down, check the continuity of the 2 cores of the cable and measure its total resistance (must be <500 Ohms).

Screen Continuity
Ensure that the screen is isolated from the loop cores and that it is continuous. Ensure the screen is connected to terminals 3 and 6. Both the screens must be connected to the terminals provided, to ensure the product meets the European Directive on EMC.

Cable Capacitance
Too high a capacitance for the selected loop speed will result in loss of communication with the actuators.

Maximum Loop Speed
The limiting values of C and R for each speed will depend on the number of field units actually connected. The table gives the total figures for systems including the capacitance of the field units. Deduct 2.2nF for each field unit to determine the maximum cable capacitance allowed at each speed.

Connecting Up
Connect the Loop Cables to the Key switch module connector on a hot standby system or the Current Loop module on a single system. Leave the actuators all without power except for the one furthest from Loop Port A.

- Wire the system as indicated in S720E Section 2
- Measure C and R and determine the maximum possible loop speed.
- If C and R not known, use 110 Baud.

Baud Rate	Typical Loop Distance (km) with 1.5mm 2 cable			R max (Ohms)	C max (µF)*
	60	120	240		
110	20.3	20.3	20.3	500	4.5
300	17.1	15.9	13.7	500	2.1
600	12.2	11.1	8.8	500	1.54
1200	4.1	2.9	0.6	500	0.6
2400	1.5	0.3	N/A	500	0.3

* The C max figure is the maximum value for the network capacitance including the field unit capacitance.

Field wiring errors are the most common cause of system malfunction.

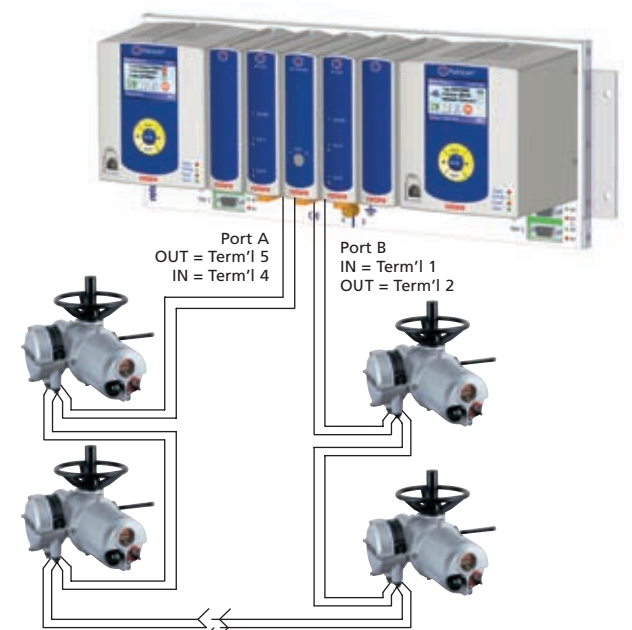

4. Setting Up using local HMI (See S720E Section 5)

Navigation:

ENTER Selects a highlighted element on the screen or completes the entry of information.

BACK moves up one level in the menu of the displays, returning to the previous screen viewed.

NEXT only functions if there is more data to show than fits on the screen as depicted by the small arrows on the right side of the screen.

◀▶ arrow keys allow active items within a page display to be highlighted and change a numeric value.

For commissioning (Section 6) this function should be ENABLED

In most cases the default settings for the master station will be suitable to get started.

- The Current Loop Parameters **must be set correctly** to match the field network and host communications parameters.
- Host Port Settings **must be adjusted** to match the host system parameters
- Network Settings **must be adjusted** to match the host system parameters

Default Settings	
Host Settings	
IP Address	10.200.1.1
Netmask	255.255.255.0
Port 1 (RS485)	
Baud Rate	9600 Baud
Parity	Odd
Port 2 (RS232)	
Baud Rate	9600 Baud
Parity	Odd
P2 Modbus Address	240
Option Module	
Host	
Port 1 Database	Generic
Port 2 Database	Generic
Ethernet Database	Generic
Alarms	Separate
Current Loop Option	
Loop Speed	1200 Baud
Highest FCU Address	60
Loop Speed Doubling	Off
DV Convert	On
Retain Data	Off
Security	
PIN	PIN disabled
Control Permit	
Serial Port 1	Enabled
Serial Port 2	Enabled
Ethernet	Enabled
Webpage	Disabled
Keypad	Enabled
ESD	
Serial ESD	Disabled
Ethernet ESD	Disabled
Webpage ESD	Disabled
Hardwired ESD	Disabled
Keypad	Disabled
M/S Settings	
Port 1 Standby Mode	Passive
Port 2 Standby Mode	Passive
Ethernet Standby Mode	Passive
Copy Options	
Settings (H/S)	Yes
Settings (Single)	No
Tag (H/S)	Yes
Tag (Single)	No
Modbus Address (H/S)	Yes
Modbus Address (Single)	No
IP Address (H/S)	No
IP Address (Single)	No

5. Setting Up Using a Laptop (See S720E Section 6)

The master station includes a set of Web pages for setting up and controlling the system.

These are accessed by connecting a laptop/PC to the master station Ethernet port on the front of the CPU.



Adjusting the Network Settings of the Laptop/PC (requires PC admin rights)

- Open the Control Panel and select Network Connections, click on 'Local Area Connection' and its status window will open.
- Click on 'Properties' and a second window will open. Select 'Internet Protocol TCP/IP' and click on the Properties button.
- Next select 'Use the following IP address' to make the laptop/PC to adopt a fixed IP address and enter an address of 10.200.1.3 and a subnet mask of 255.255.255.0, click on the OK button and the window will close.
- Click OK on the 'Local Area Connection Properties' window and then Close the status window, the Network Connections window and the Control Panel. Reboot the laptop/PC to ensure that the new settings take effect. Connect the cable between the laptop/PC and the master station front connector.

Accessing the Pakscan P3 Internal Web Pages

- Start Internet Explorer and browse to IP address 10.200.1.1, (<http://10.200.1.1>).
- The browser will then access the master station and bring up the opening page of the master station.
- Log in with a user name of admin and a password of admin.
- Select and edit the configuration pages.

Upon reconnecting your Laptop/PC to a LAN you must restore your original network settings.



6. Commissioning (See S720E Section 7)

This procedure requires webpage control to be enabled. The current loop must be commissioned to enable the system to locate and identify every actuator. Use the laptop/PC to perform the commissioning. Note that all the actuators must be available, though they may be locked in 'local stop'. Set the master station to match the highest FCU address.

The two wire loop and all the actuators must be connected to the master station, with all the actuators left without power except for the one furthest from port A. Disconnect the wires from port B and browse to the master station web pages on the PC. Go to **System Diagnostics** and then select **Option 2 Diagnostics** by clicking on the **diagnostics** button.

- Reset the network (current loop). The status information changes to the configuration stages. Once complete the actuator furthest from port A should be on the Network Map.
- Power on the next nearest actuator and reset the network again, this actuator should appear on the list. Continue to power on the actuators and reset the network working back towards port A until all the actuators are connected and appear on the map.
- Then connect the port B wires and disconnect the port A wires. Reset the network and check that all the actuators are still on the map. Having verified the loop wiring and the connection of all the actuators in both directions, finally connect the port A wires, reset the loop and all the actuators will be ready for control.

The commissioning sequence can also be carried out using the master station local HMI.

To control an actuator, if site permission is granted, go to **FCU Menu** to open the page showing all the connected actuators. The **FCU Control** button will bring up the page showing the actuator information in more detail and the actuator can be moved by the **Open** and **Close** buttons and any alarms present displayed by clicking **Show Alarms**.

